

# NCP151

## LDO Regulator - Dual, High PSRR

### 300 mA

The NCP151 is a dual linear regulator capable of supplying 300 mA output current from 1.7 V input voltage. The device provides wide output voltage range from 0.8 V up to 3.6 V. In order to optimize performance for battery operated portable applications, the NCP151 employs the dynamic quiescent current adjustment for very low  $I_Q$  consumption at no-load.

#### Features

- Operating Input Voltage Range 1.7 V to 5.5 V
- Available in Fixed Voltage Option: 0.8 V to 3.6 V
- $\pm 2\%$  Accuracy Over Load/Temperature
- Low Quiescent Current Typ. 100  $\mu$ A
- Low Dropout: 210 mV for 300 mA @ 2.8 V
- Low Dropout: 370 mV for 300 mA @ 1.8 V
- High PSRR: Typ. 70 dB at 1 kHz @ OUT1, OUT2
- Stable with a 1  $\mu$ F Small Case Size Ceramic Capacitors
- Available in XDFN4, 1 mm  $\times$  1 mm  $\times$  0.4 mm
- These Devices are Pb-Free, Halogen Free/BFR Free and are RoHS Compliant

#### Typical Applications

- PDAs, Mobile Phones, GPS, Smartphones
- Wireless Handsets, Wireless LAN Devices, Bluetooth<sup>®</sup>, Zigbee<sup>®</sup>
- Bitcoin Miners
- Portable Medical Equipment
- Other Battery Powered Equipment

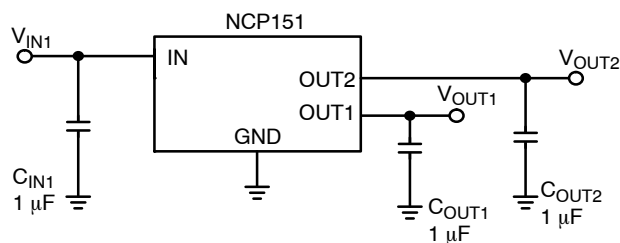

Figure 1. Typical Application Schematic



ON Semiconductor<sup>®</sup>

[www.onsemi.com](http://www.onsemi.com)



1

XDFN4  
CASE 711AJ

#### MARKING DIAGRAM

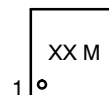

XX = Specific Device Code  
M = Date Code

#### PIN CONNECTIONS

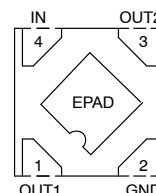

(Top View)

#### ORDERING INFORMATION

See detailed ordering and shipping information on page 2 of this data sheet.

# NCP151

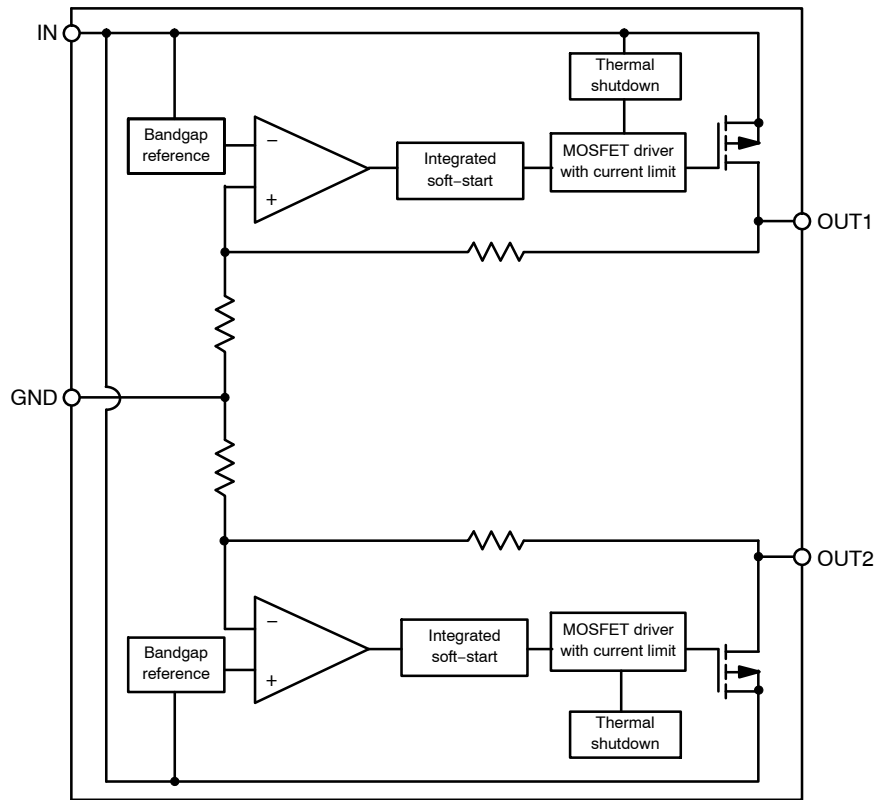

Figure 2. Simplified Schematic Block Diagram

## PIN FUNCTION DESCRIPTION

Pin No. XDFN4	Pin Name	Description
4	IN	Input voltage supply pin.
1	OUT1	Regulated output voltage. The output should be bypassed with small 1 $\mu$ F ceramic capacitor.
3	OUT2	Regulated output voltage. The output should be bypassed with small 1 $\mu$ F ceramic capacitor.
2	GND	Common ground connection.
EPAD	EPAD	Expose pad can be tied to ground plane for better power dissipation.

## ABSOLUTE MAXIMUM RATINGS

Rating	Symbol	Value	Unit
Input Voltage (Note 1)	$V_{IN}$	-0.3 V to 6 V	V
Output Voltage	$V_{OUT1}, V_{OUT2}$	-0.3 to $V_{IN} + 0.3$ , max 6 V	V
Output Short Circuit Duration	$t_{SC}$	unlimited	s
Maximum Junction Temperature	$T_J$	150	$^{\circ}$ C
Storage Temperature	$T_{STG}$	-55 to 150	$^{\circ}$ C
ESD Capability, Human Body Model (Note 2)	$ESD_{HBM}$	2000	V
ESD Capability, Machine Model (Note 2)	$ESD_{MM}$	200	V

Stresses exceeding those listed in the Maximum Ratings table may damage the device. If any of these limits are exceeded, device functionality should not be assumed, damage may occur and reliability may be affected.

- Refer to ELECTRICAL CHARACTERISTICS and APPLICATION INFORMATION for Safe Operating Area.
- This device series incorporates ESD protection and is tested by the following methods:  
 ESD Human Body Model tested per EIA/JESD22-A114.  
 ESD Machine Model tested per EIA/JESD22-A115.  
 Latchup Current Maximum Rating tested per JEDEC standard: JESD78.

# NCP151

## THERMAL CHARACTERISTICS

Rating	Symbol	Value	Unit
Thermal Characteristics, XDFN4 (Note 3), Thermal Resistance, Junction-to-Air	$R_{\theta JA}$	170	$^{\circ}\text{C}/\text{W}$

3. Measured according to JEDEC board specification. Detailed description of the board can be found in JESD51-7.

## ELECTRICAL CHARACTERISTICS

$-40^{\circ}\text{C} \leq T_J \leq 85^{\circ}\text{C}$ ;  $V_{IN} = V_{OUT(NOM)} + 1\text{ V}$  for  $V_{OUT}$  options greater than 1.5 V. Otherwise  $V_{IN} = 2.5\text{ V}$ , whichever is greater,  $I_{OUT} = 1\text{ mA}$ ;  $C_{IN} = C_{OUT} = 1\text{ }\mu\text{F}$ , unless otherwise noted. Typical values are at  $T_J = +25^{\circ}\text{C}$ .

Parameter	Symbol	Test Conditions		Min	Typ	Max	Unit
Operating Input Voltage	$V_{IN}$			1.7		5.5	V
Output Voltage Accuracy	$V_{OUT}$	$V_{OUT(NOM)} \leq 2\text{ V}$		-40		+40	mV
		$V_{OUT(NOM)} > 2\text{ V}$		-2		+2	%
Line Regulation	LineReg	$V_{OUT(NOM)} + 0.5\text{ V} \leq V_{IN} \leq 5.5\text{ V}$ , ( $V_{IN} \geq 1.7\text{ V}$ )			0.01	0.1	%/V
Load Regulation	LoadReg	$I_{OUT} = 1\text{ mA to } 300\text{ mA}$			12	30	mV
Dropout Voltage (Note 5)	$V_{DO1}$	OUT1	$V_{OUT(NOM)} = 2.8\text{ V}$ $I_{OUT} = 300\text{ mA}$		210	370	mV
	$V_{DO2}$	OUT2	$V_{OUT(NOM)} = 1.8\text{ V}$ $I_{OUT} = 300\text{ mA}$		370	560	
Current Limit	$I_{CL}$	OUT1, OUT2, $V_{OUT} = 90\% V_{OUT(NOM)}$		325	600		mA
Short Circuit Current	$I_{SC}$	OUT1, OUT2, $V_{OUT} = 0\text{ V}$			600		
Quiescent Current	$I_Q$	$I_{OUT1} = 0\text{ mA}$ , $I_{OUT2} = 0\text{ mA}$			100	200	$\mu\text{A}$
$V_{OUT}$ Slew Rate (Note 6)	$V_{OUT\_SR}$	$V_{OUT} = 1.8\text{ V}$ , $I_{OUT} = 10\text{ mA}$	Normal (Version A)		100		mV/ $\mu\text{s}$
			Slow (Version C)		30		
Power Supply Rejection Ratio	PSSR	$V_{IN} = 3.8\text{ V}$ , $V_{OUT1} = 2.8\text{ V}$ , $I_{OUT} = 10\text{ mA}$	$f = 1\text{ kHz}$		70		dB
Output Voltage Noise	$V_N$	$f = 10\text{ Hz to } 100\text{ kHz}$ , $I_{OUT1} = 10\text{ mA}$			70		$\mu\text{V}_{RMS}$
Thermal Shutdown Threshold	$T_{SDH}$	Temperature rising			160		$^{\circ}\text{C}$
	$T_{SDL}$	Temperature falling			140		$^{\circ}\text{C}$

Product parametric performance is indicated in the Electrical Characteristics for the listed test conditions, unless otherwise noted. Product performance may not be indicated by the Electrical Characteristics if operated under different conditions.

4. Performance guaranteed over the indicated operating temperature range by design and/or characterization. Production tested at  $T_A = 25^{\circ}\text{C}$ .

Low duty cycle pulse techniques are used during the testing to maintain the junction temperature as close to ambient as possible.

5. Dropout voltage is characterized when  $V_{OUT}$  falls 100 mV below  $V_{OUT(NOM)}$ .

6. Please refer OPN to determine slew rate. NCP151A – normal speed. NCP151C – slower speed.

# NCP151

## TYPICAL CHARACTERISTICS

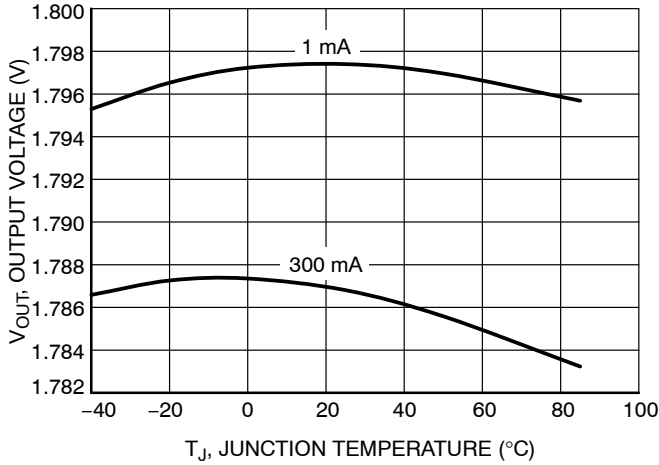

Figure 3. Output Voltage vs. Temperature

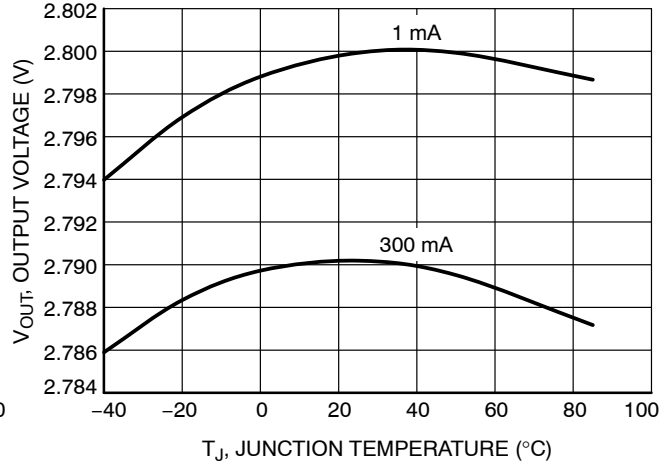

Figure 4. Output Voltage vs. Temperature

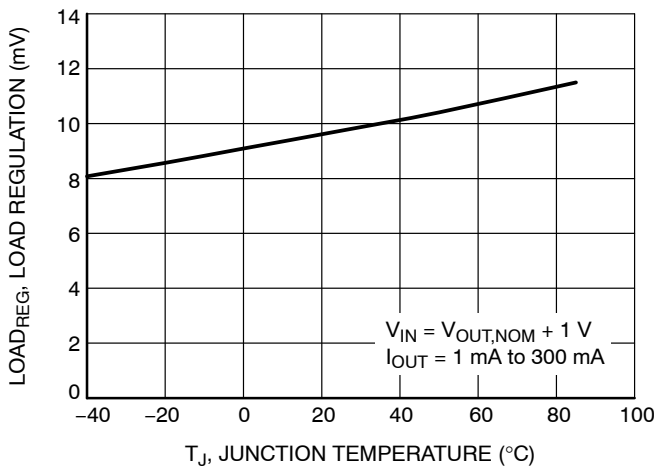

Figure 5. Load Regulation vs. Temperature

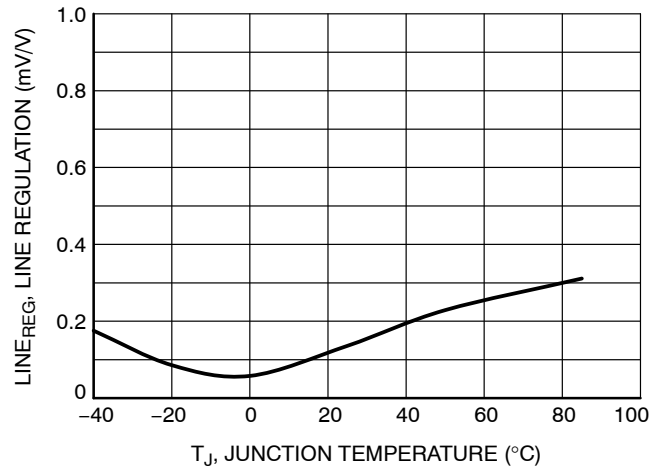

Figure 6. Line Regulation vs. Temperature

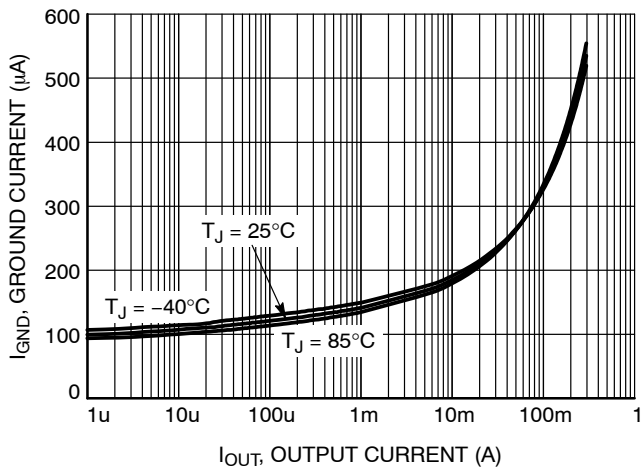

Figure 7. Ground Current vs. Output Current  
 $V_{OUT,NOM} = 1.8\text{ V}$  – One Output Load

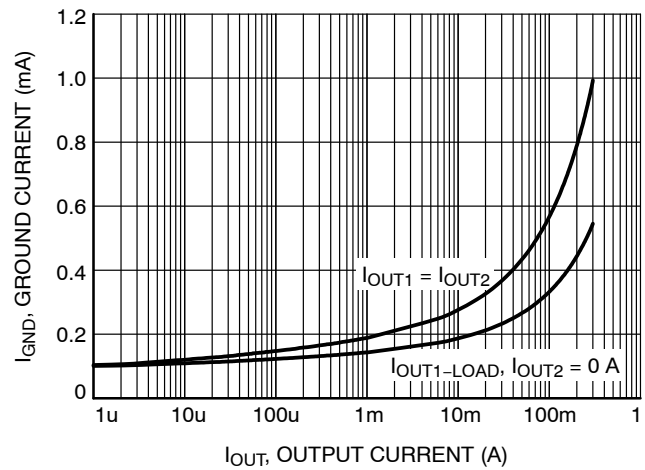
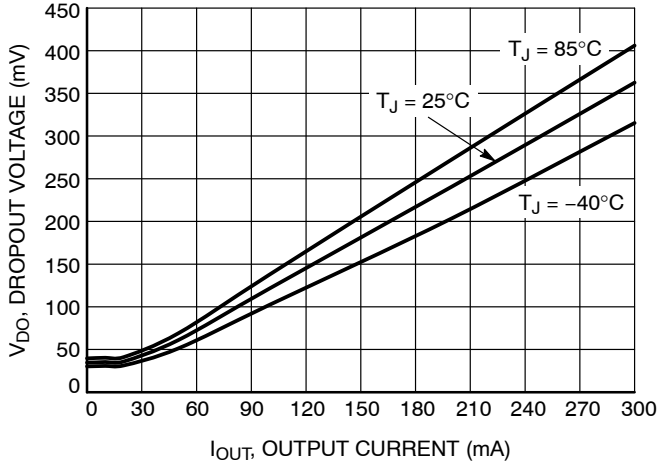

Figure 8. Ground Current vs. Output Current – Different Load Combinations

# NCP151

## TYPICAL CHARACTERISTICS



**Figure 9. Dropout Voltage vs. Output Current -  $V_{OUT,NOM} = 1.8\text{ V}$**

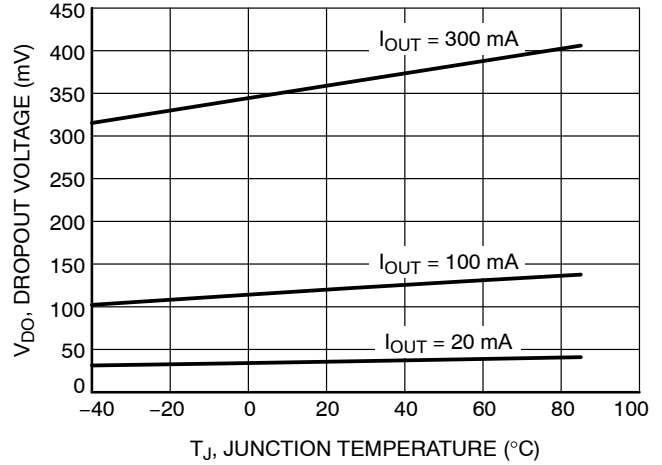

**Figure 10. Dropout Voltage vs. Temperature -  $V_{OUT,NOM} = 1.8\text{ V}$**

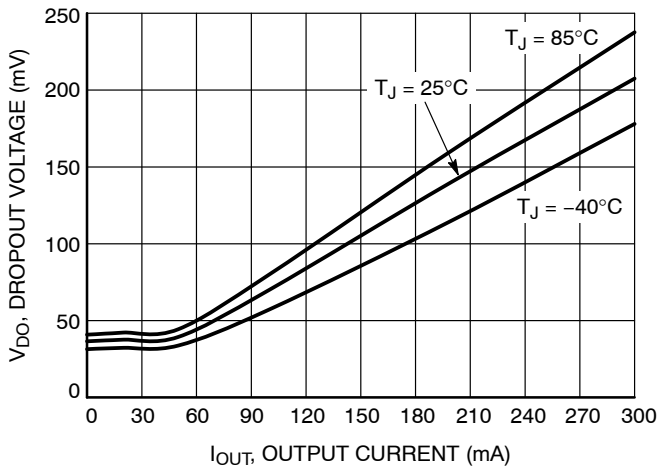

**Figure 11. Dropout Voltage vs. Output Current -  $V_{OUT,NOM} = 2.8\text{ V}$**

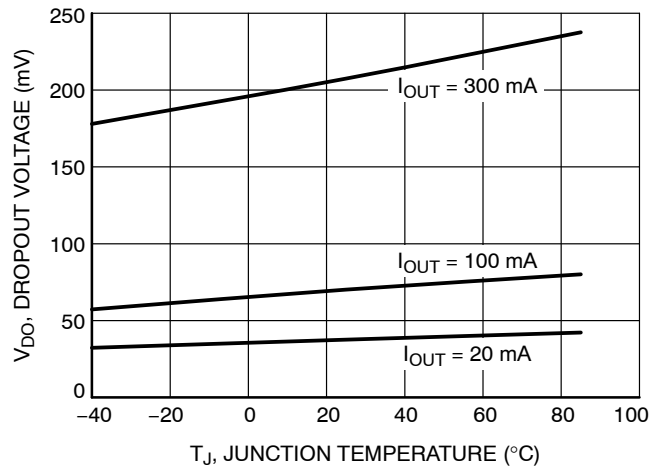

**Figure 12. Dropout Voltage vs. Temperature -  $V_{OUT,NOM} = 2.8\text{ V}$**

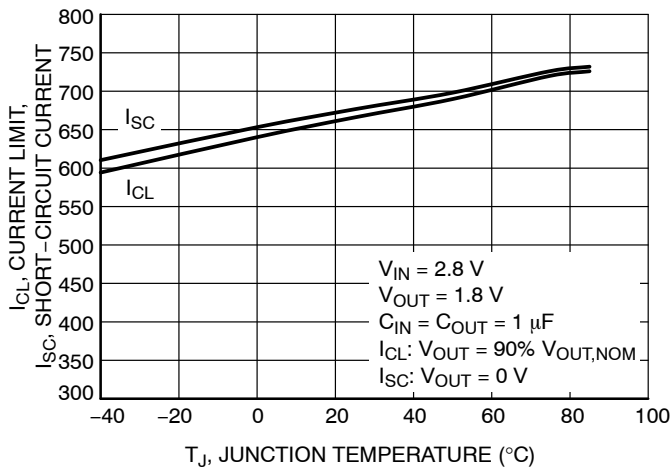

**Figure 13. Short-circuit Current, Current Limit vs. Temperature**

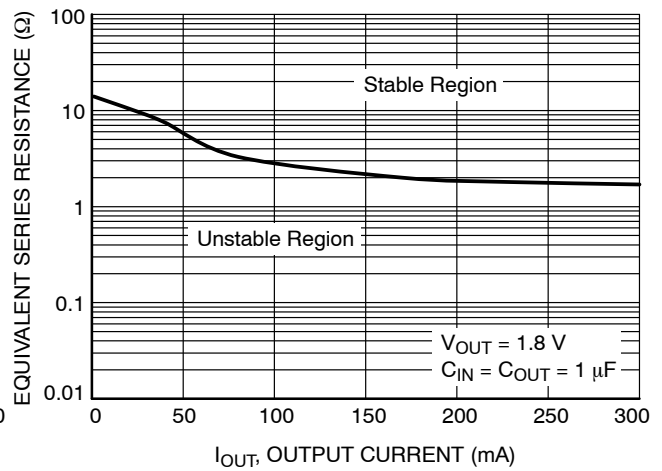

**Figure 14. Maximum  $C_{OUT}$  ESR Value vs. Output Current**

TYPICAL CHARACTERISTICS

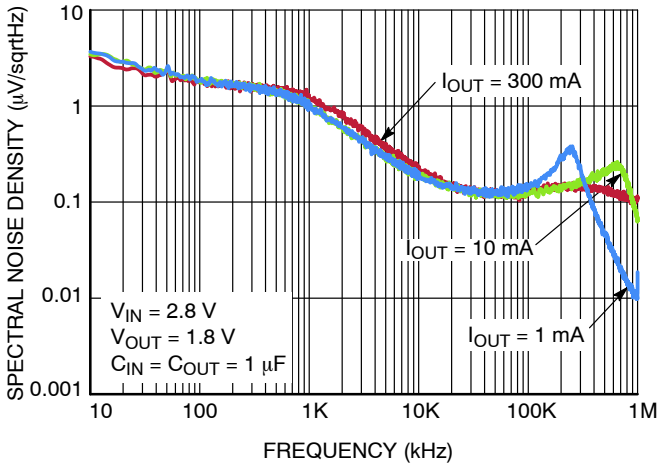

Figure 15. Spectral Noise Density vs. Frequency,  $V_{OUT} = 1.8\text{ V}$

$I_{OUT}$	RMS Output Noise ( $\mu\text{V}$ )	
	10 Hz – 100 kHz	100 Hz – 100 kHz
1 mA	72.7	69.2
10 mA	71.5	67.9
300 mA	78.7	76.1

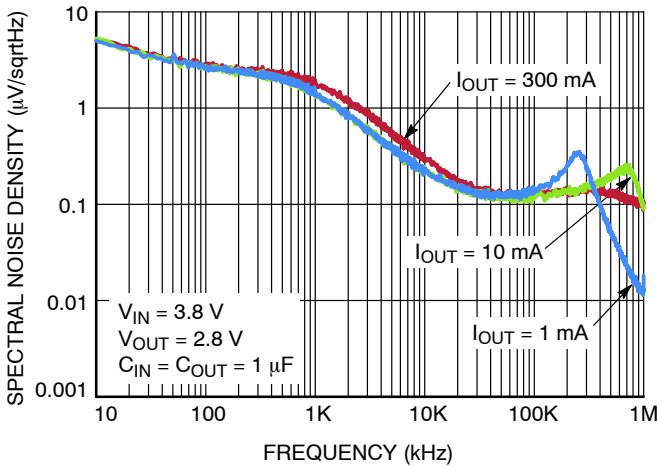

Figure 16. Spectral Noise Density vs. Frequency,  $V_{OUT} = 2.8\text{ V}$

$I_{OUT}$	RMS Output Noise ( $\mu\text{V}$ )	
	10 Hz – 100 kHz	100 Hz – 100 kHz
1 mA	93.8	88.5
10 mA	92.3	86.9
300 mA	111.1	106.2

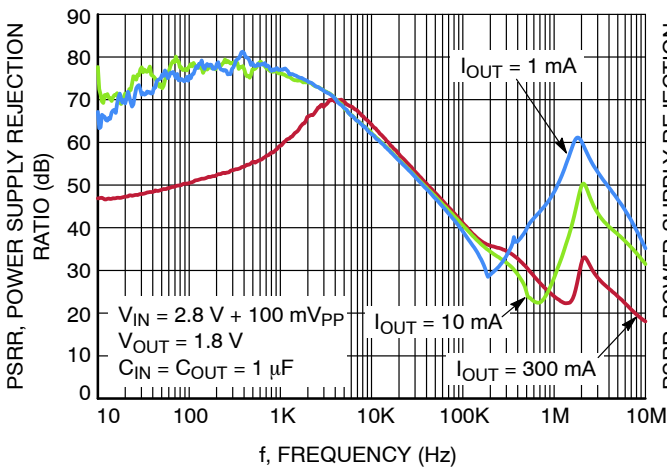

Figure 17. PSRR vs. Frequency,  $V_{OUT} = 1.8\text{ V}$

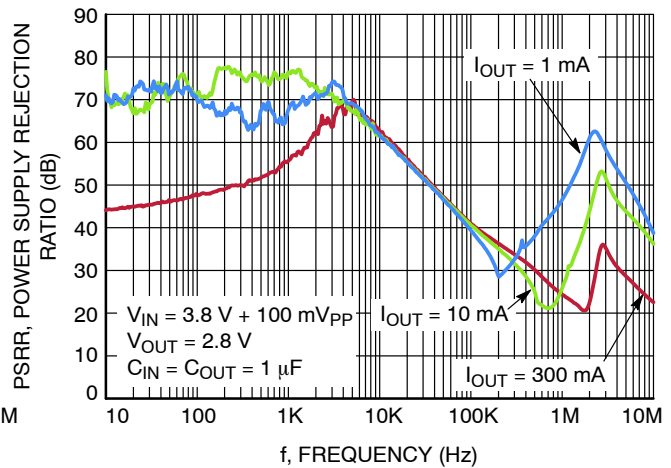
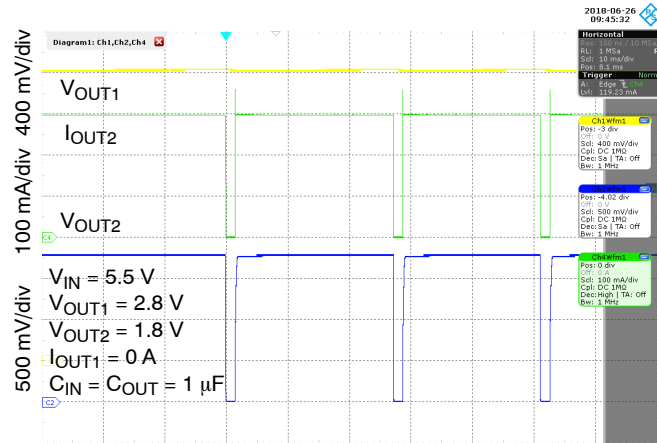
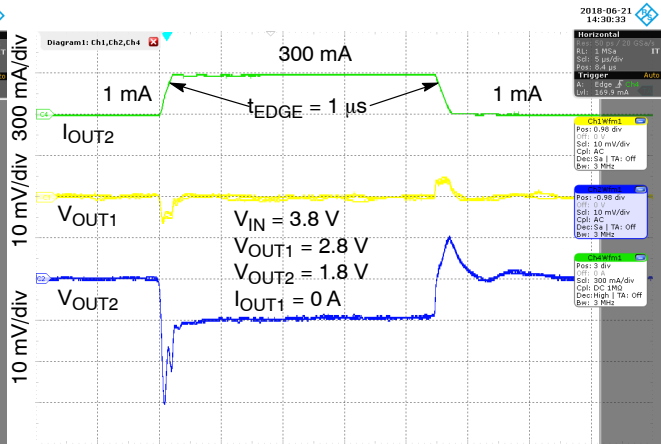
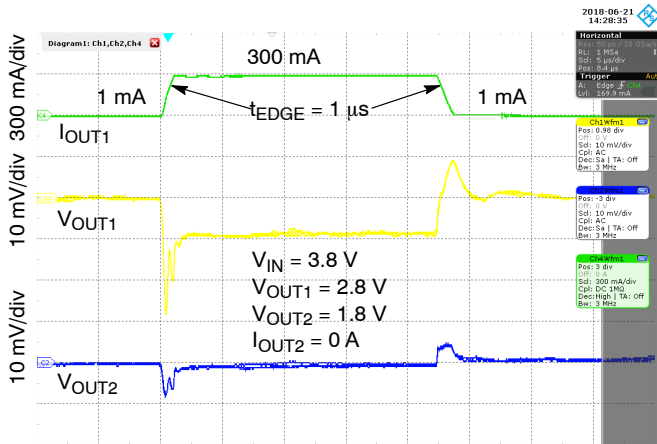
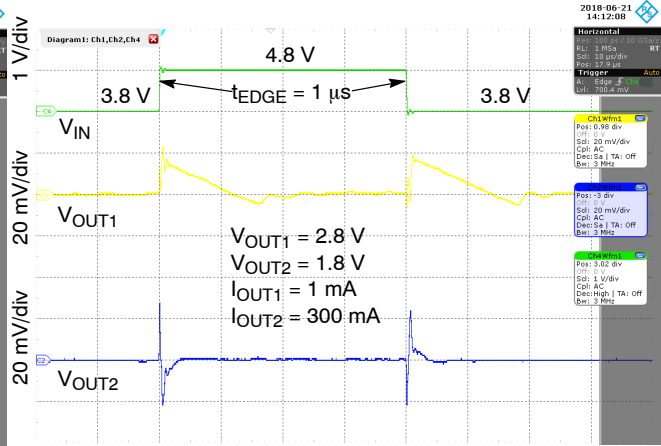
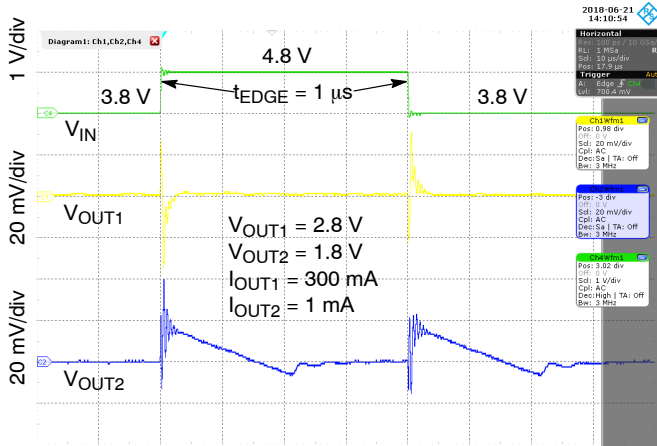

Figure 18. PSRR vs. Frequency,  $V_{OUT} = 2.8\text{ V}$

# NCP151

## TYPICAL CHARACTERISTICS



APPLICATIONS INFORMATION

**General**

The NCP151 is a dual output 300 mA Low Dropout Linear Regulator. This device delivers high PSRR (70 dB at 1 kHz) and very good dynamic performance as load/line transients. In connection with low quiescent current this device is very suitable for various battery powered applications such as tablets, cellular phones, wireless and many others. Each output is fully protected in case of output overload, output short circuit condition and overheating, assuring a very robust design. The NCP151 device is housed in DFN-4 1 mm x 1 mm package which is useful for space constrained application.

**Input Capacitor Selection (CIN)**

Input capacitor connected as close as possible is necessary for ensure device stability. The X7R or X5R capacitor should be used for reliable performance over temperature range. The value of the input capacitor should be 1 μF or greater to ensure the best dynamic performance. This capacitor will provide a low impedance path for unwanted AC signals or noise modulated onto constant input voltage. There is no requirement for the ESR of the input capacitor but it is recommended to use ceramic capacitors for their low ESR and ESL. A good input capacitor will limit the influence of input trace inductance and source resistance during sudden load current changes.

**Output Decoupling**

The NCP151 requires an output capacitor connected as close as possible to the output pin of the regulator. The recommended capacitor value is 1 μF and X7R or X5R dielectric due to its low capacitance variations over the specified temperature range. The NCP151 is designed to remain stable with minimum effective capacitance of 0.68 μF to account for changes with temperature, DC bias and package size. Especially for small package size capacitors such as 0201 the effective capacitance drops rapidly with the applied DC bias. Please refer to Figure 24.

There is no requirement for the minimum value of Equivalent Series Resistance (ESR) for the C<sub>OUT</sub> but the maximum value of ESR should be less than 1.7 Ω.

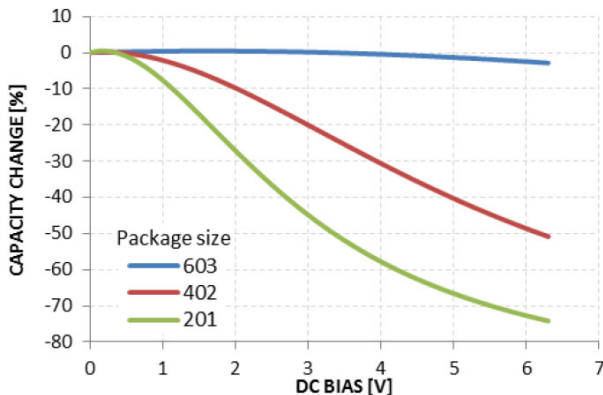

Figure 24. Capacity vs. DC Bias Voltage

Larger output capacitors and lower ESR could improve the load transient response or high frequency PSRR. It is not recommended to use tantalum capacitors on the output due to their large ESR. The equivalent series resistance of tantalum capacitors is also strongly dependent on the temperature, increasing at low temperature.

**Output Current Limit**

Output Current is internally limited within the IC to a typical 600 mA. The NCP151 will source this amount of current measured with a voltage drops on the 90% of the nominal V<sub>OUT</sub>. If the Output Voltage is directly shorted to ground (V<sub>OUT</sub> = 0 V), the short circuit protection will limit the output current to 600 mA (typ). The current limit and short circuit protection will work properly over whole temperature range and also input voltage range. There is no limitation for the short circuit duration.

**Thermal Shutdown**

When the die temperature exceeds the Thermal Shutdown threshold (TSD – 160°C typical), Thermal Shutdown event is detected and the affected channel is turn-off. Second channel still working. The channel which is overheated will remain in this state until the die temperature decreases below the Thermal Shutdown Reset threshold (TSDU – 140°C typical).

The channel which is overheated will remain in this state until the die temperature decreases below the Thermal Shutdown Reset threshold (TSDU – 140°C typical). Once the device temperature falls below the 140°C the appropriate channel is enabled again. The thermal shutdown feature provides the protection from a catastrophic device failure due to accidental overheating. This protection is not intended to be used as a substitute for proper heat sinking. The long duration of the short circuit condition to some output channel could cause turn-off other output when heat sinking is not enough and temperature of the other output reach TSD temperature.

**Power Dissipation**

As power dissipated in the NCP151 increases, it might become necessary to provide some thermal relief. The maximum power dissipation supported by the device is dependent upon board design and layout. Mounting pad configuration on the PCB, the board material, and the ambient temperature affect the rate of junction temperature rise for the part. The maximum power dissipation the NCP151 can handle is given by:

$$P_{D(MAX)} = \frac{[85^{\circ}\text{C} - T_A]}{\theta_{JA}} \quad (\text{eq. 1})$$

The power dissipated by the NCP151 for given application conditions can be calculated from the following equations:

# NCP151

$$P_D \approx V_{IN} \times I_{GND} + I_{OUT1}(V_{IN} - V_{OUT1}) + I_{OUT2}(V_{IN} - V_{OUT2}) \quad (\text{eq. 2})$$

## Reverse Current

The PMOS pass transistor has an inherent body diode which will be forward biased in the case that  $V_{OUT} > V_{IN}$ . Due to this fact in cases, where the extended reverse current condition can be anticipated the device may require additional external protection.

## Power Supply Rejection Ratio

The NCP151 features very good Power Supply Rejection ratio. If desired the PSRR at higher frequencies in the range 100 kHz – 10 MHz can be tuned by the selection of  $C_{OUT}$  capacitor and proper PCB layout.

## Turn-On Time

The turn-on time is defined as the time period from EN assertion to the point in which  $V_{OUT}$  will reach 98% of its nominal value. This time is dependent on various application conditions such as  $V_{OUT(NOM)}$ ,  $C_{OUT}$  and  $T_A$ . The NCP151 provides two options of  $V_{OUT}$  ramp-up time. The NCP151A have normal slew rate, typical 100 mV/μs and NCP151C and provide slower option with typical value 30 mV/μs which is suitable for camera sensor and other sensitive devices.

## PCB Layout Recommendations

To obtain good transient performance and good regulation characteristics place  $C_{IN}$  and  $C_{OUT}$  capacitors close to the device pins and make the PCB traces wide. In order to minimize the solution size, use 0402 capacitors. Larger copper area connected to the pins will also improve the device thermal resistance. The actual power dissipation can be calculated from the equation above (Equation 2). Expose pad should be tied the shortest path to the GND pin.

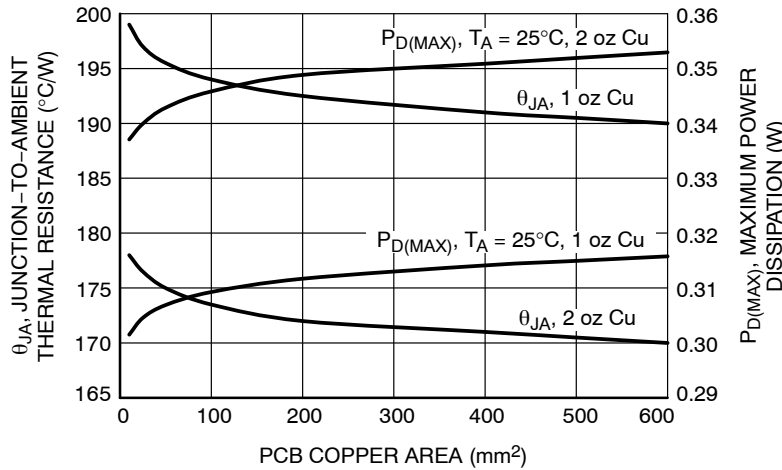

Figure 25.  $\theta_{JA}$  vs. Copper Area (XDFN4)

## ORDERING INFORMATION

Device	Marking	Voltage option OUT1/OUT2	Vout Slew Rate OUT1/OUT2	Package	Shipping†
NCP151AAMX180070TCG	YE	1.8 V/0.70 V	Normal/Normal	XDFN4 CASE 711AJ (Pb-Free)	3000 Units/ Tape & Reel
NCP151AAMX180075TCG	YA	1.8 V/0.75 V	Normal/Normal		
NCP151AAMX280180TCG	YC	2.8 V/1.8 V	Normal/Normal		
NCP151AAMX330180TCG	YD	3.3 V/1.8 V	Normal/Normal		
NCP151CCMX280180TCG	ZC	2.8 V/1.8 V	Slow/Slow		

†For information on tape and reel specifications, including part orientation and tape sizes, please refer to our Tape and Reel Packaging Specifications Brochure, BRD8011/D.

# MECHANICAL CASE OUTLINE PACKAGE DIMENSIONS



**XDFN4 1.0x1.0, 0.65P**  
CASE 711AJ  
ISSUE C

DATE 08 MAR 2022

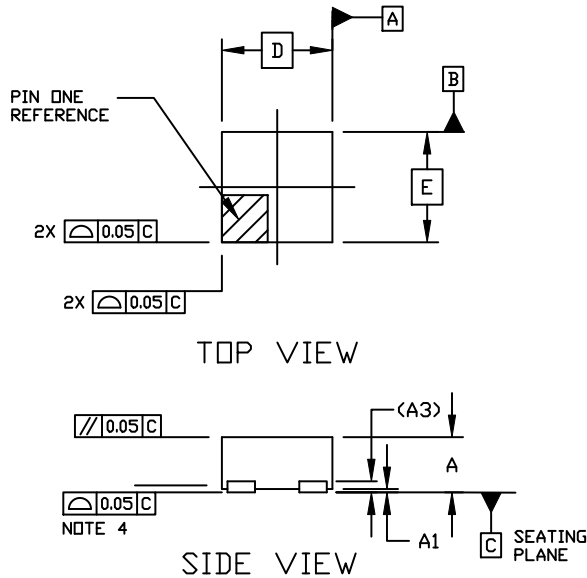

**NOTES:**

1. DIMENSIONING AND TOLERANCING PER ASME Y14.5M, 1994.
2. CONTROLLING DIMENSION: MILLIMETERS
3. DIMENSION *b* APPLIES TO THE PLATED TERMINALS AND IS MEASURED BETWEEN 0.15 AND 0.20 FROM THE TERMINAL TIPS.
4. COPLANARITY APPLIES TO THE EXPOSED PAD AS WELL AS THE TERMINALS.

DIM	MILLIMETERS		
	MIN	NOM	MAX
A	0.33	0.38	0.43
A1	0.00	---	0.05
A3	0.10 REF		
<i>b</i>	0.15	0.20	0.25
<i>b</i> 2	0.02	0.07	0.12
D	0.90	1.00	1.10
D2	0.43	0.48	0.53
E	0.90	1.00	1.10
<i>e</i>	0.65 BSC		
L	0.20		0.30
L2	0.07		0.17

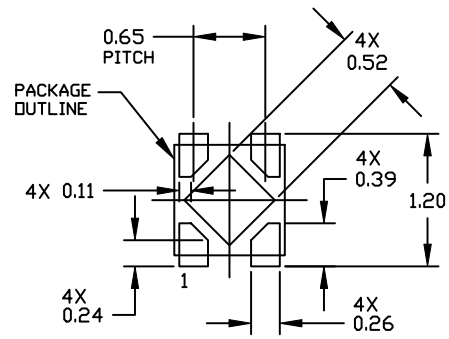
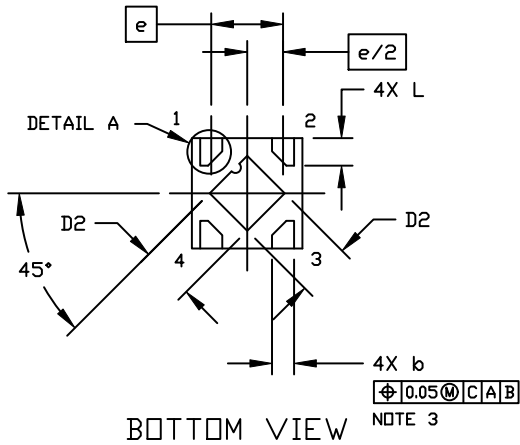

**RECOMMENDED  
MOUNTING FOOTPRINT**

\* FOR ADDITIONAL INFORMATION ON OUR Pb-FREE STRATEGY AND SOLDERING DETAILS, PLEASE DOWNLOAD THE ONSEMI SOLDERING AND MOUNT TECHNIQUES REFERENCE MANUAL, SOLDERRM/D

**GENERIC  
MARKING DIAGRAM\***

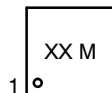

XX = Specific Device Code  
M = Date Code

\*This information is generic. Please refer to device data sheet for actual part marking. Pb-Free indicator, "G" or microdot "•", may or may not be present. Some products may not follow the Generic Marking.

<b>DOCUMENT NUMBER:</b>	<b>98AON67179E</b>	Electronic versions are uncontrolled except when accessed directly from the Document Repository. Printed versions are uncontrolled except when stamped "CONTROLLED COPY" in red.
<b>DESCRIPTION:</b>	<b>XDFN4, 1.0X1.0, 0.65P</b>	<b>PAGE 1 OF 1</b>

onsemi and ONSEMI are trademarks of Semiconductor Components Industries, LLC dba onsemi or its subsidiaries in the United States and/or other countries. onsemi reserves the right to make changes without further notice to any products herein. onsemi makes no warranty, representation or guarantee regarding the suitability of its products for any particular purpose, nor does onsemi assume any liability arising out of the application or use of any product or circuit, and specifically disclaims any and all liability, including without limitation special, consequential or incidental damages. onsemi does not convey any license under its patent rights nor the rights of others.

**onsemi**, **Onsemi**, and other names, marks, and brands are registered and/or common law trademarks of Semiconductor Components Industries, LLC dba "**onsemi**" or its affiliates and/or subsidiaries in the United States and/or other countries. **onsemi** owns the rights to a number of patents, trademarks, copyrights, trade secrets, and other intellectual property. A listing of **onsemi**'s product/patent coverage may be accessed at [www.onsemi.com/site/pdf/Patent-Marking.pdf](http://www.onsemi.com/site/pdf/Patent-Marking.pdf). **onsemi** reserves the right to make changes at any time to any products or information herein, without notice. The information herein is provided "as-is" and **onsemi** makes no warranty, representation or guarantee regarding the accuracy of the information, product features, availability, functionality, or suitability of its products for any particular purpose, nor does **onsemi** assume any liability arising out of the application or use of any product or circuit, and specifically disclaims any and all liability, including without limitation special, consequential or incidental damages. Buyer is responsible for its products and applications using **onsemi** products, including compliance with all laws, regulations and safety requirements or standards, regardless of any support or applications information provided by **onsemi**. "Typical" parameters which may be provided in **onsemi** data sheets and/or specifications can and do vary in different applications and actual performance may vary over time. All operating parameters, including "Typicals" must be validated for each customer application by customer's technical experts. **onsemi** does not convey any license under any of its intellectual property rights nor the rights of others. **onsemi** products are not designed, intended, or authorized for use as a critical component in life support systems or any FDA Class 3 medical devices or medical devices with a same or similar classification in a foreign jurisdiction or any devices intended for implantation in the human body. Should Buyer purchase or use **onsemi** products for any such unintended or unauthorized application, Buyer shall indemnify and hold **onsemi** and its officers, employees, subsidiaries, affiliates, and distributors harmless against all claims, costs, damages, and expenses, and reasonable attorney fees arising out of, directly or indirectly, any claim of personal injury or death associated with such unintended or unauthorized use, even if such claim alleges that **onsemi** was negligent regarding the design or manufacture of the part. **onsemi** is an Equal Opportunity/Affirmative Action Employer. This literature is subject to all applicable copyright laws and is not for resale in any manner.

## PUBLICATION ORDERING INFORMATION

### LITERATURE FULFILLMENT:

Email Requests to: [orderlit@onsemi.com](mailto:orderlit@onsemi.com)

**onsemi Website:** [www.onsemi.com](http://www.onsemi.com)

### TECHNICAL SUPPORT

**North American Technical Support:**

Voice Mail: 1 800-282-9855 Toll Free USA/Canada

Phone: 011 421 33 790 2910

**Europe, Middle East and Africa Technical Support:**

Phone: 00421 33 790 2910

For additional information, please contact your local Sales Representative

# Mouser Electronics

Authorized Distributor

Click to View Pricing, Inventory, Delivery & Lifecycle Information:

[onsemi:](#)

[NCP151AAMX180070TCG](#) [NCP151AAMX180075TCG](#) [NCP151AAMX280180TCG](#) [NCP151AAMX330180TCG](#)  
[NCP151CCMX280180TCG](#)